

GLOBAL ACADEMIC RESEARCH INSTITUTE

COLOMBO, SRI LANKA



GARI International Journal of Multidisciplinary Research

ISSN 2659-2193

Volume: 04 | Issue: 03

On 15th June 2018

<http://www.research.lk>

Author: Drakshayini M. N, Dr. Arun Vikas Singh

T John Institute of Technology, India

GARI Publisher | Digital Technology | Volume: 04 | Issue: 03

Article ID: IN/GARI/ICET/2018/108 | Pages: 12-22 (10)

ISSN 2659-2193 | Edit: GARI Editorial Team

Received: 18.05.2018 | Publish: 15.06.2018

UNIFIED DIGITAL AUDIO AND DIGITAL VIDEO BROADCASTING SYSTEM USING ORTHOGONAL FREQUENCY DIVISION MULTIPLEXING (OFDM) SYSTEM

¹Drakshayini M N, ²Dr. Arun Vikas Singh

¹drakshayini@tjohngroup.com , ²arunsingh@tjohngroup.com

ABSTRACT

The foremost objective of Digital Audio Broadcasting (DAB) is to provide high definition radio which offers very high audio quality and data services to the fixed and mobile receivers. Digital video broadcasting (DVB) is the set of standard for the broadcast transmission of digital television signal and DVB is the replacement for existing analogue television transmission. Orthogonal Frequency Division Multiplexing (OFDM) system is an efficient multicarrier digital modulation technique and which compromises high spectral efficiency. This paper presents the unified approach for DAB and DVB using OFDM system. Bit Error Rate (BER) performance analysis of DAB and DVB system is performed and also Bit Error Rate (BER) performance analysis of unified DAB and DVB is performed using OFDM system. Comparisons are made between the theoretical values and with the obtained results. Keywords: OFDM, DAB, DVB, QAM, BER, SNR.

INTRODUCTION

Present Wireless communication demands high spectral efficiency and high robustness. OFDM is an efficient digital multicarrier modulation technique which provides high spectral efficiency and high robustness [1]. Applications of OFDM are DAB, DVB, ADSL, LTE, Wireless LAN standards and Digital Radio Mondiale etc [2-3]. This paper presents the unified approach for DAB and DVB using OFDM system. Bit Error Rate (BER) performance analysis of DAB and DVB system is performed and also Bit Error Rate (BER) performance analysis of unified DAB and DVB is performed using OFDM system. Comparisons are made between the theoretical values and with the obtained results. Unified system is developed using MATLAB programming and simulation results are observed, for the real time audio and video input, output is obtained with minimal bit error rate.

Orthogonal frequency division multiplexing

OFDM is a method of multicarrier digital modulation technique in which a signal is divided into several narrow band channels at different frequencies [4]. Every sub channels are modulated by using subcarriers of different frequencies. OFDM modulation is used in many applications because it provides high efficiency in combating multipath fading and also provides high data-rate transmission [5]. Hence efficient utilization of bandwidth is possible with OFDM when compared to conventional modulation schemes. In OFDM the subcarriers are chosen in such a way that they are orthogonal to each other so that cross talk among subcarriers can be eliminated. Equation (1) describes the orthogonality of two signals which are linearly independent.

$$\int_x^y X_p(t) X_q^*(t) dt = \begin{cases} K & \text{for } p = q \\ 0 & \text{for } p \neq q \end{cases} \quad (1)$$

Where $[x, y]$ is one symbol period.

OFDM symbol is defined mathematically in equation (2).

$$Y(n) = 1/N \sum_{k=0}^{N-1} y(k) e^{j2\pi kn/N} \quad 0 \leq n \leq N-1 \quad (2)$$

Where N = FFT length, $y(k)$ = Complex value data, k = kth element of the array.

Figure 1 illustrates the block diagram of the OFDM systems. symbol mapping block performs one to one mapping takes binary data input and each bit is mapped to complex valued number on the constellation. The various types of modulation can be used in this stage is Binary Phase Shift Keying (BPSK), Quadrature Phase Shift Keying (QPSK), 16-Quadrature Amplitude Modulation (QAM), 64-Quadrature Amplitude Modulation, 128-Quadrature Amplitude Modulation and 256-Quadrature Amplitude Modulation. On the receiver, symbol de-mapping transforms the complex valued number into the binary data with respect to their phase and amplitude values. Serial symbol sequences are converted into parallel sequence in serial to parallel converter block and also sequence of data symbols are reorganized into a number of smaller sub-set of data symbols in this block. Across the receiver parallel to serial

converter block are used to convert parallel data sequence into serial sequence of OFDM symbols and also used to reorganize the data symbol to its original form. In the pilot insertion block pilot carriers are interleaved into the OFDM Symbol. Pilot carrier is a non-information carrier and pilot carrier does not carry any information. Pilot carrier is the complex valued number and it is a point represented on the constellation. Basically pilot carriers are used to overcome the frequency and timing error and also in channel estimation stage pilot carriers are used for the estimation where exactly the OFDM symbol begins. Inverse Fast

Fourier Transform (IFFT) block generates an OFDM symbol, These OFDM symbols are real valued and multiplexed subcarriers.

IFFT transforms frequency domain symbols into time domain waveform. IFFT produces the combined set of subcarriers which are multiplexed and are orthogonal to each other.

The guard interval insertion block affixes a cyclic prefix to the beginning of every OFDM which reduces the effects of Inter symbol Interference (ISI) and Inter carrier Interference (ICI) [6].

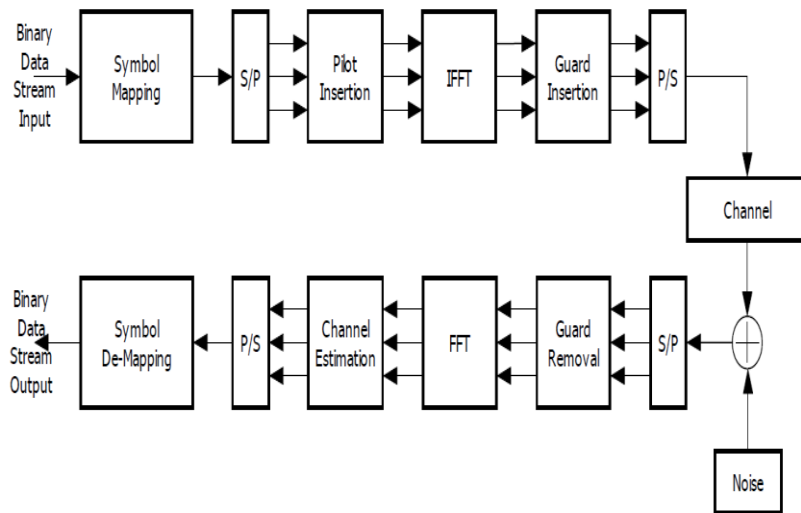

Figure 1: Block diagram of typical Orthogonal frequency division multiplexing System.

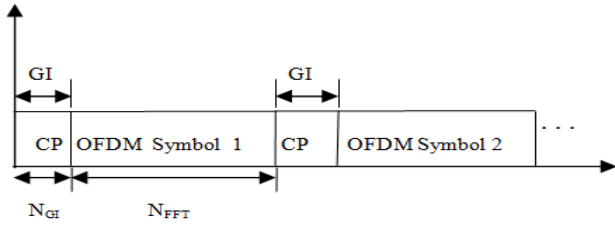

Figure 2: Time domain representation of a sequence of Orthogonal frequency division multiplexing symbols with cyclic prefix guard interval.

Figure 2 illustrates the OFDM symbol with cyclic prefix guard interval. In the receiver guard removal block eliminates the cyclic prefix from the OFDM symbol.

Parallel to serial conversion stage transforms the OFDM Symbols into the serial sequence of OFDM symbols which is real-valued base band OFDM waveform. At the receiver OFDM waveforms are converted back to parallel sequence.

The length of serial sequence OFDM is defined in equation (3)

$$Z_{len} = S [N_{GI} + N_{FFT}] \quad (3)$$

where Z_{len} = OFDM frame length, S = Number of OFDM symbols, N_{FFT} = Duration of OFDM symbol, N_{GI} = Length of guard interval.

Review on digital audio broadcasting

FM has many advantages over AM but FM suffers from Multipath fading and ISI. FM is suitable for fixed reception than mobile reception since FM suffers from loss of broadcasting quality during mobile reception. These issues can be addressed in Digital Audio Broadcasting (DAB). DAB can be defined as digital radio or high definition radio which broadcasts wide ranges of radio services from studio to receiver. DAB is designed to obtain high quality digital audio programs and data services to fixed, mobile and handy devices. It was established in 1990s by Eureka 147 DAB.

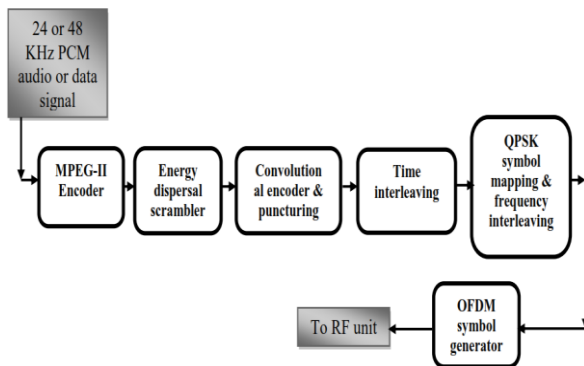

Figure 3: DAB transmitter block diagram

Figure 3 illustrates the transmitter block diagram of the DAB system. The overall DAB transmission can be distributed to the number of functional blocks and these blocks process the input signal and produces the complete DAB signal. The audio signal or data signal is given as input to MPEG layer-2 encoder which generates the encoded data. In order to make sure that the appropriate energy dispersal in the transmitted signal, distinct inputs of the energy dispersal scramblers is to be scrambled with the help of modulo-2 addition and PRBS.

Punctured convolutional encoder does the forward error correction and convolutional encoding by taking the input scrambled bit stream. Interleaving block rearranges the coded bit-stream. Time interleaving increase the robustness of the transmitted data. Time interleaved data is then fed to QPSK modulation block which takes binary data stream input and each bit is represented as complex valued number on the constellation and performs one to one mapping. After the QPSK modulation symbols are given to OFDM block where final DAB transmission signals are generated [7].

Review on digital video broadcasting

Figure 4 illustrates the transmitter block diagram of the DVB system. Transmission and storage of audio, video and programs are performed by Source coding and MPEG2 and these are standard container format. Program stream (PS) is just a container format for audio, video and data and performs multiplexing of audio, video and data. Transport stream (TS) is a Container format for transmission as well as storage of audio, video and data. Example movie, news cart, sports news which displays on TV. Encoder block provides the first level of protection in the transmitter. Encoder block helps in detecting and correcting multiple symbol errors. The type of encoder used is the convolution encoder. Convolution encoders are used for error detection and error correction. Block inter leaver is also called random inter leaver which rearranges the data sequence to provide the robustness.

Mapper performs symbol mapping on one to one basis. QAM is the combination of both amplitude and phase modulation. 16 QAM refers to number of message points on the constellation, it is 4 bits per symbol(1/4 bit rate). Existing system uses QAM modulation so 16 constellation points are used [8].

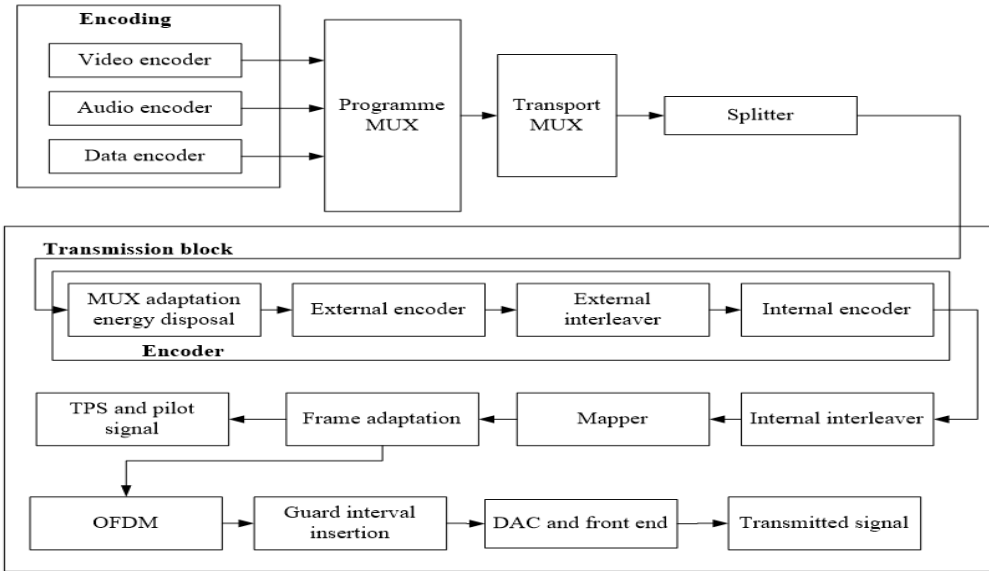

Figure 4: Block diagram of DVB

Performance analysis DAB system using MATLAB Simulation

DAB system is modeled and simulated using MATLAB programming. The objective of this simulation is to evaluate the BER and SNR of the DAB system using convolutional coding using puncturing method. Puncturing method lets the encoding and decoding of higher rate codes by standard rate 1/2 encoders and decoders. The simulation parameters for DAB mode II are listed

in Table 1. Frame based processing is done in this simulation model under AWGN channel for the performance analysis. DAB frame structure is designed by using one synchronization channel for transmission frame synchronization and transmitter identification, three Fast Information Channel [FIC] used for quick access of information in the receiver and 72 Main Service Channel [MSC] used to convey audio and data services.

Table 1: Mode II Parameters of DAB system

Parameter	Value
Number of Subcarriers	384
Subcarrier Spacing	4 kHz
Transmission Frame duration	24 ms
Symbol duration	321 μs
Guard Interval	62 μs
Null Symbol duration	324 μs
OFDM symbols per transmission frame	76

OFDM Symbols with SC data	1
OFDM Symbols with FIC data	3
OFDM Symbols with MSC data	72

This section illustrates the simulation results of DAB system for AWGN channel. An audio input is given to the DAB system which is shown in figure 5. An audio signal is processed and transmitted under AWGN fading channel. Figure 6 illustrates BER vs. SNR for DAB system.

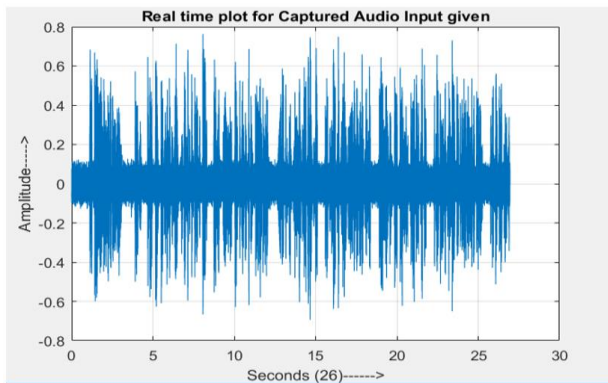

Figure 5: Audio input to DAB system

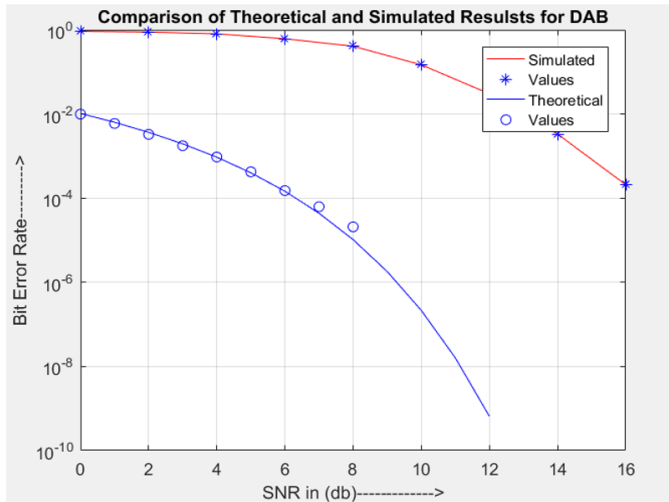

Figure 6: BER vs. SNR for DAB system under AWGN channel

DVB system using MATLAB Simulation

Block diagram of the DVB system is as shown in figure 4. Initially the video is captured which is divided into a finite number of frames. The frames are then converted from parallel to serial data.

Table 2: Mode II Parameters of DAB system

Parameter	Value
Number of Subcarriers	2K mode:1705 8K mode:6817
Subcarrier Spacing	2K mode:4464 8K mode:1116
Channel spacing B[MHZ]	6,7,8
Symbol length, Tu(μs)	2K mode:224 8K mode:896
Guard Interval	1/4, 1/8, 1/16, 1/32
Sub-carrier spacing Δf=1/ Tu Hz	2K mode:4464 8K mode:1116
Net bit Rate, R(Mbit/S)	4.98-31.67(typically 24.13)
FFT size [K=1024]	2K 8K
Sub-carrier modulation Scheme	QPSK 16QAM or 64QAM
Symbol length, Tu(μs)	2K mode:224 8K mode:896

The data is then encoded using the cyclic encoder which is then passed into an interleaver. Here for protection two levels of encoders are used which are external encoder and internal encoder. Two levels of interleaver are used here which are external interleaver and internal interleaver. The interleaved data is then passed into a modulation block. Modulation method chosen is 16 QAM. The modulated signal is

then passed into an OFDM block which performs the modulation and multiplexing. The simulation parameters for DVB – T are listed in Table 2.

This section illustrates the simulation results of DVB system for AWGN channel. A video input is transmitted under AWGN channel. Figure 7 illustrates BER vs. SNR for DVB system.

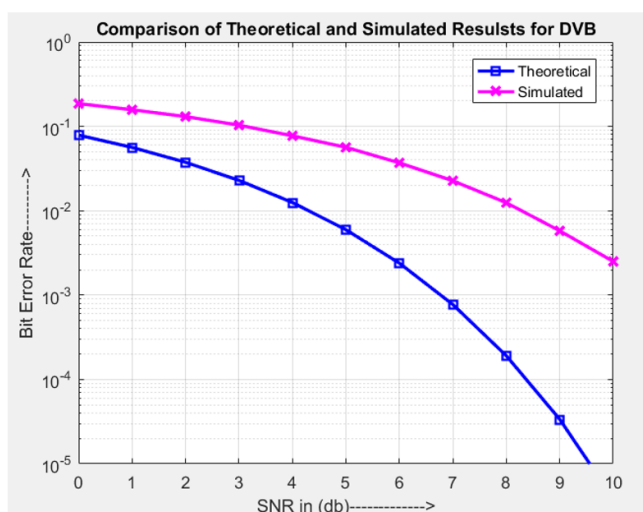

Figure 7. BER vs. SNR for DVB system under AWGN channel

Unified DAB and DVB system using MATLAB Simulation

This section illustrates the simulation results of Unified DAB and DVB system for AWGN channel. A video input is transmitted under AWGN channel. Figure 8 illustrates BER vs. SNR for Unified DAB and DVB system.

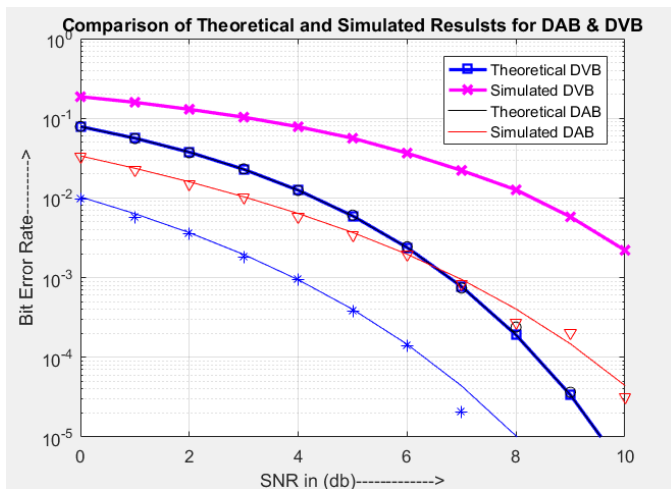

Figure 8. BER vs. SNR unified DAB and DVB system

CONCLUSION

A simulation based performance analysis of DAB and DVB system and also unified DAB and DVB system is presented in this paper. Many applications use OFDM system because of its high spectral efficiency. Outcome of the system will be confirmed by multiple and extended simulation based experiments in OFDM. The proposed system will reduce the design complexity, conserves design time, Power consumption, reduced cost as compared to multiple designs for different standards.

REFERENCES

- T. Hwang, C. Yang, G. Wu, S. Li and G. Y. Li, "OFDM and Its Wireless Applications: A Survey," in IEEE Transactions on Vehicular Technology, vol. 58, no. 4, pp. 1673-1694, May 2009.
- A. S. Bhosle and Z. Ahmed, "Modern tools and techniques for OFDM development and PAPR reduction," 2016 International Conference on Electrical, Electronics, and Optimization Techniques (ICEEOT), Chennai, 2016, pp. 290-292.
- R. Umar, F. Yang and S. Mughal, "BER performance of a polar coded OFDM over different channel models," 2018 15th International Bhurban Conference on Applied Sciences and Technology (IBCAST), Islamabad, 2018, pp. 764-769.
- N. LaSorte, W. J. Barnes and H. H. Refai, "The History of Orthogonal Frequency Division Multiplexing," Global Telecommunications Conference, 2008. IEEE GLOBECOM 2008. IEEE, New Orleans, LO, 2008, pp. 1-5. doi: 10.1109/GLOCOM.2008.ECP.690 doi: 10.1109/TLA.2016.7430062
- C. Yu, C. H. Sung, C. H. Kuo, M. H. Yen and S. J. Chen, "Design and implementation of a low-power OFDM receiver for wireless communications," in IEEE Transactions on Consumer Electronics, vol. 58, no. 3, pp. 739-745, August 2012. doi: 10.1109/TCE.2012.6311312
- Drakshayini M N, Dr. Arun Vikas Singh, "A Review on Reconfigurable Orthogonal Frequency Division Multiplexing (OFDM) System for Wireless Communication", 2nd International Conference on Applied and

Theoretical Computing and Communication
Technology(iCATccT), 978-1-5090-2399-
8/16/\$31.00 c, 2016 IEEE.

Drakshayini M. N, Dr. Arun Vikas Singh “An Efficient
Orthogonal Frequency Division Multiplexing
(OFDM) System and Performance Analysis of
Digital Audio Broadcasting (DAB) System”,
International Journal of Computer
Applications (0975 – 8887) Volume 148 –
No.8, August 2016.

Drakshayini M N, Arun Vikas Singh, Vyshanava
Nandini S, “Performance Of Digital Video
Broadcastingterrestrial (Dvb-T) Using Ofdm
As System”, IJRET: International Journal of
Research in Engineering and Technology,
eISSN: 2319-1163, pISSN: 2321-7308,
Volume: 05 Special Issue: 04, ICESMART-
2016, Ma